

# TTL33-A

## LINE ARRAY MODULE



The TTL33-A is a full range, ultracompact, wide dispersion, line array module that sets a new standard in the touring and theatre sound reinforcement.

TTL33-A is a 3-way active system featuring with 2 x 8" neo woofer 64 mm voice coil in a bandpass low frequency configuration, 1 x 8" neo midrange 64 mm voice coil in horn loaded configuration, 3 x 1" neo compression driver 37 mm voice coil, titanium dome, in horn-array configuration. Each transducer has been specifically designed for the application. The 2 woofer provides large excursion and very light weight, the midrange has an incredibly high BL for best vocal presence, the unique compression driver design offer the minimum spacing between throats to avoid HF cancellation. Thanks to the extensive use of neodymium and new basket designs, the total weight of the 6 transducers is less than 8 Kg!

The amplifier section features 750 watt switching power supply module, 500 watt low frequency digital amplifier module, 500 watt midrange digital amplifier module, 250 watt high frequency digital amplifier module, extra capacitor bus able to sustain the voltage for 100 ms burst signals. The total available power supply power is 750 watts and can be distributed to the 3 final amplifier sections. Each amplifier section has a very high maximum output power capability in order to provide, when necessary, maximum output bursts in a specific frequency range.

The input section provides In/Out XLR connectors, system sensitivity control, full range – high pass switch, air absorption correction (near–mid–far distance) switches, mid-bass coupling correction (depending on number of cabinets) switches, 4 status LEDs. The 24 bits, 96 KHz sampling, floating point DSP provides linear phase crossovers, system equalization, fast limiter, RMS limiter and configuration control.

The AC panel features In/Out Powercon connectors, On/Off switch. A small fan, speed controlled, guarantee the air circulation inside the amplifier in the most demanding situations. The cabinet is in marine baltic birch plywood, coated with high resistance epoxy paint. The mechanical suspension and orientation system is in high quality steel, very precise and easy to use. The suspension system is directly connected to the aluminum sides of the cabinet. The suspension system is designed to have a safety factor 7 up to 16 speakers per side.

### Applications

- Touring sound reinforcement for mid-sized venues
- High quality reinforcement of music and speech
- Medium to large theatres and night clubs
- Stadiums, arenas, concert halls and other fixed venue installations
- Corporate A/V presentation

### Features

- Very compact size ( 760 x 300 x 450 mm / 29.92" x 11.81" x 17.71")
- Maximum output per size available on market
- Minimum weight (32 kg / 70,54 lbs)
- Wide, constant directivity, horizontal coverage angle
- 6 high power neodymium transducers
- 750 watt, 3 high power switching amplifiers
- 96 khz, 24 bit, floating DSP
- XLR in/out, powercon in/out
- Baltic birch cabinet

### ACOUSTICAL SPECIFICATIONS

Frequency response:	60 Hz- 20 KHz
Max SPL:	134 dB
Horizontal coverage angle:	100°
Vertical coverage angle:	15°
Compression driver:	3 x 1" neo, 37 mm voice coil
Midrange:	8" neo, 64 mm voice coil
Woofer:	2 x 8" neo, 64 mm voice coil

### INPUT SECTION

Input signal (Impedance):	bal/unbal
Input/Output connector:	xlr
Input sensitivity:	- 2 dBu / + 4 dBu

### PROCESSOR SECTION

Crossover frequencies:	400 Hz / 1800 Hz
Protections:	thermal, hf
Sensitivity control:	yes
Limiter:	fast limiter
High pass:	yes, 100 Hz
Controls:	hf correction, cluster size, HPF

### AMPLIFIER

Power supply:	switching 750 Watt
High frequencies:	D / 250 Watt
Mid frequencies:	D / 500 Watt
Low frequencies:	D / 500 Watt
Cooling:	convection/forced
Connection:	powercon in/out

### PHYSICAL

Height:	300 mm (11.81")
Width:	760 mm (30.00")
Depth:	450 mm (18.2")
Weight:	32.5 kg (71.5 lbs)
Cabinet:	baltic birch
Hardware:	side fly fittings
Handles:	2 on side
Colour:	Black

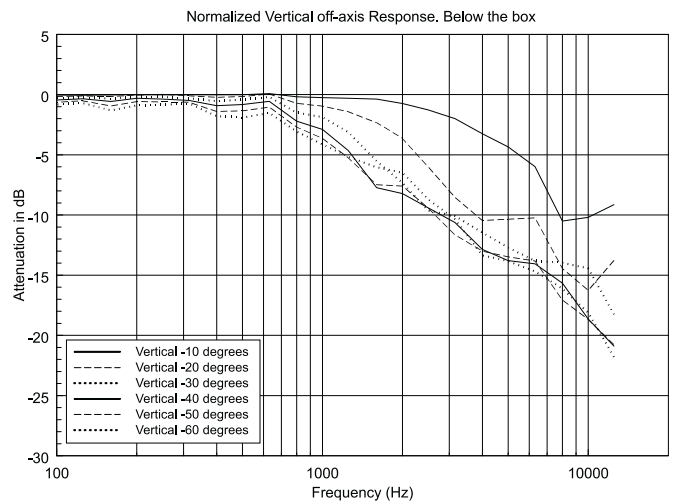
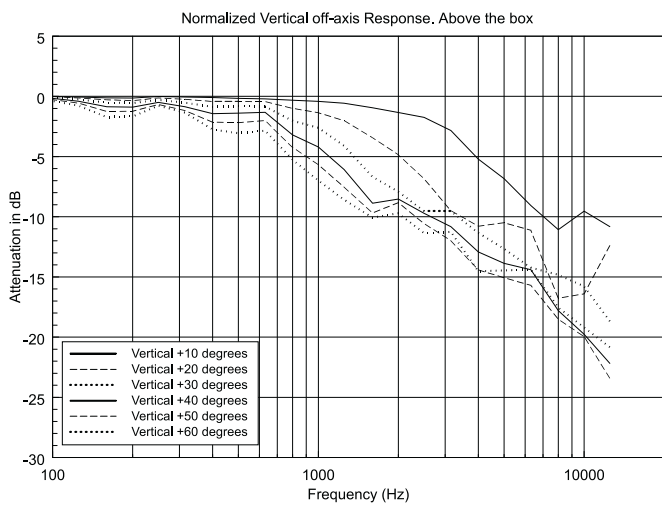
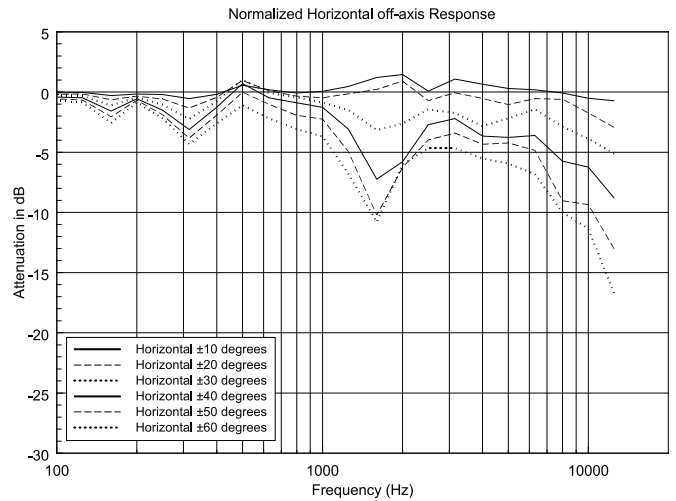
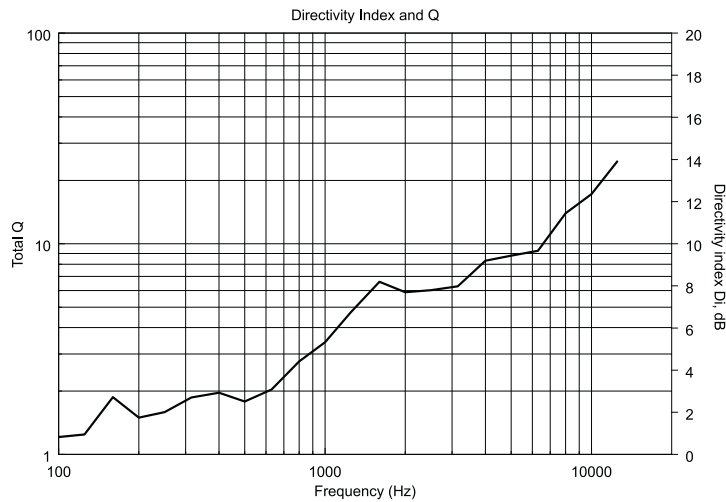
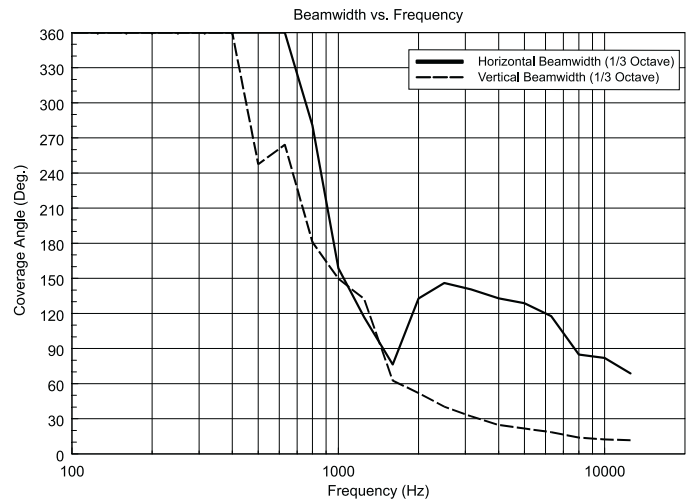
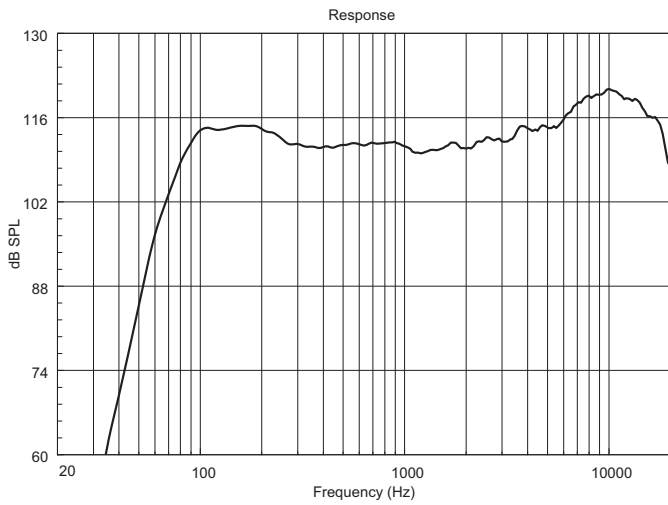

**Horizontal 1/3 Polar Plot**

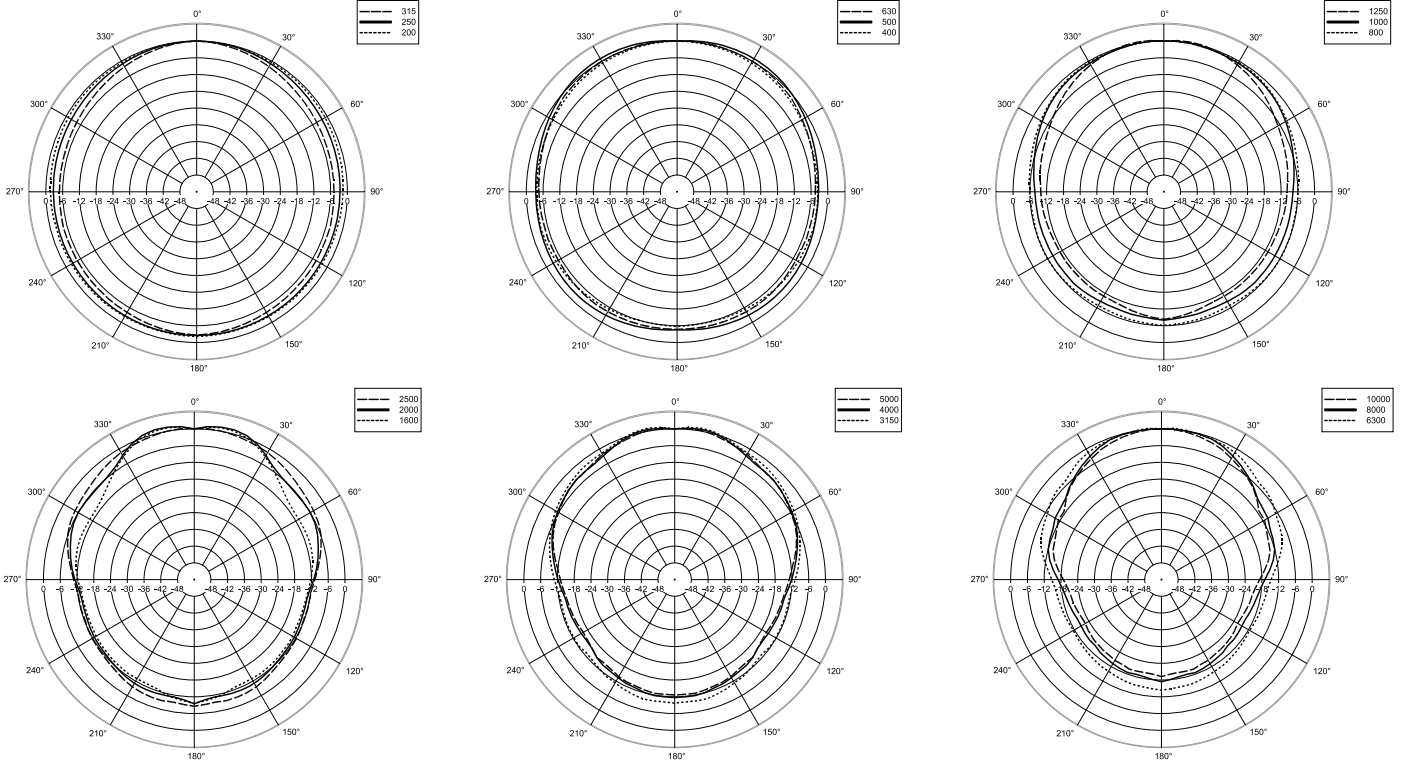

**Vertical 1/3 Polar Plot**

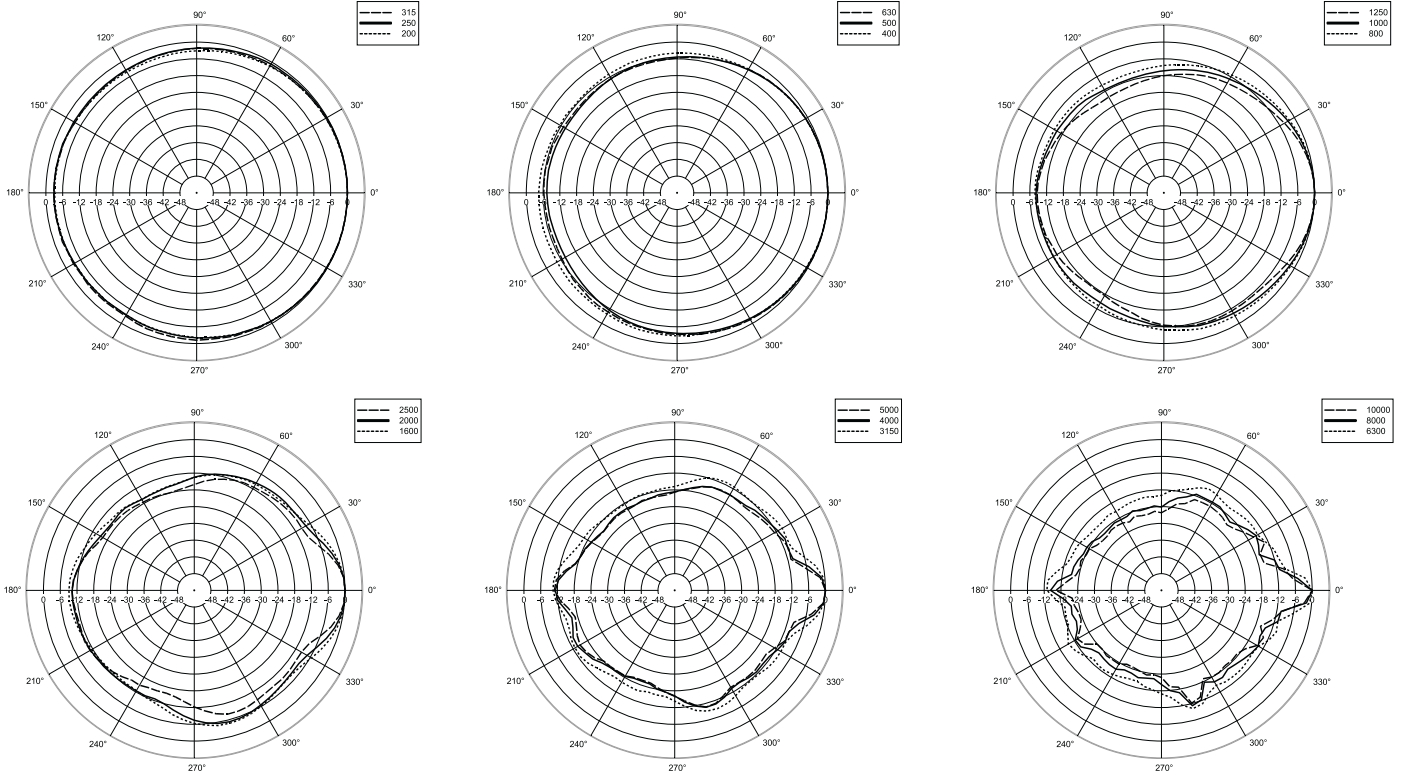

CSI PRODUCT SPECIFICATIONS FOR DESIGNERS, SPECIFIERS, AND CONSULTANTS (ALSO KNOWN AS "A&E SPECIFICATIONS")

The following are "Part 2 Products" CSI-type specifications. It is assumed that "Part 1 General – Administrative and Procedures" and "Part 3 Execution – Installation and Maintenance" are part of an overall audio system or project specification.

**PART 2 PRODUCTS**

**2.01 Approved Manufacturer/Product**

A. RCF, Via Raffaello 13, 42100 Mancasale, Reggio Emilia, Italy.

B. Model number: TTL33-A

**2.02 Design**

Configuration	3 way line array module
LF Sub-section	2 x 8" neodymium woofer, 64 mm voice coil
MR Sub-section	8" neodymium, 64 mm voice coil
HF Sub-section	3 x 1" neodymium, 37 mm voice coil

**2.03 Acoustical Properties**

Nominal dispersion angle:	Horizontal: 100° - Vertical: 15°
Axial frequency range:	60Hz-20kHz

**2.04 Physical Properties**

Cabinet:	Baltic birch
Rigging inserts:	Side fly fittings
Color:	Black
Grille:	Custom perforated steel grille with open-cell poly fiber backing
Input Connectors:	xlr
Dimensions (H x W x D):	300 x 760 x 450 mm (11.81" x 29.92" x 17.71")
Weight:	32 kg (70.54 lbs.)

**2.05 Accessories**

FLY BAR TTL33	Suspending bar for array system TTL33-A.
STCK BAR TTL33	Accessory to add to fly bar for stacking option on sub TTL33-A. Quick lock pins to be added.
KART TTL33	Kart with wheels for 4 TTL33-A.
AC PROTECTION	Rain cover protection for TTL33-A amplifier.
AC QL-PIN TTL33-A	Kit 4 quick lock pins for TTL33-A array system.

