

# MQ 100L

## 3 WAY COLUMN SPEAKER



### MAIN APPLICATIONS

- Music applications
- Audio visual applications
- Shopping malls
- Restaurants
- Pubs
- Hotels
- Office building

### DESCRIPTION

MQ 100L is a 3 way column loudspeaker providing natural hi-fidelity sound of both speech and music, suitable for sound system having fixed loudspeakers where the environment is acoustically critical or with architectural constraints. The wide horizontal coverage angle (180°) and the vertical dispersion (60°) allow the correct sound reproduction in a wide space, in order to limit feedback and improve the sound directivity which is important, for instance, in halls having a long reverberation time.

It includes a transformer inside for the connection to (100 – 70 V) constant voltage lines, yet it can also be set to 16  $\Omega$  (low impedance connection). When connected to a 100 V line, its power can be selected among the values 40 W, 20 W, 10 W or 5 W through a rotary switch (thanks to internal transformer taps).

MQ 100L is available in white (MQ 100L-W) or black (MQ 100L-B) colour

### MAIN FEATURES

- 2 rubber surround 3.5" woofers, 2 fabric surround 3.5" woofers
- 2 cloth coated 0.75" dome tweeters
- 80 / 160 Watt (RMS/Music Power)
- 130 Hz ÷ 20 kHz
- 120 dB (1 m / POWER MAX) max. SPL
- Incl. 100V transformer multitap
- Power rotary switch
- Crossover frequency: 2000 Hz
- Type of filter 6/6/6 dB/oct
- Direct connection to Low-Z speaker lines
- Easy to install
- Simple power settings

### SPECIFICATIONS

Loudspeaker	Woofers 3.5" neodymium magnet, 0.75" dome tweeter
Power (on 8 Ohm load)	80 / 160 W (RMS / Music power)
Power	40 W - 20 W - 10 W - 5 W (100V)
Sensitivity	93 dB (1 W / 1 m)
Mx. SPL (6 W / 1 m)	120 dB(A) (1 m / POWER MAX)
Frequency Response	130 Hz – 20 kHz
Angle of coverage	270° / 150° / 110° @ 1 / 2 / 4 kHz (hor.)
Connector	Euroblock 2 pole
Body colour	White / Silver
Main body material	Auto-extinguishing high-density polystyrene
Grill material	Steel
Dimensions (HxWxD)	510 mm x 120 mm x 130 mm
Installation	Orientable support included
Max ceiling thickness	36 mm
Net weight	3 kg
Operating temperature	-25° to +55°
Relative humidity	90% non condensing



# MQ 100L

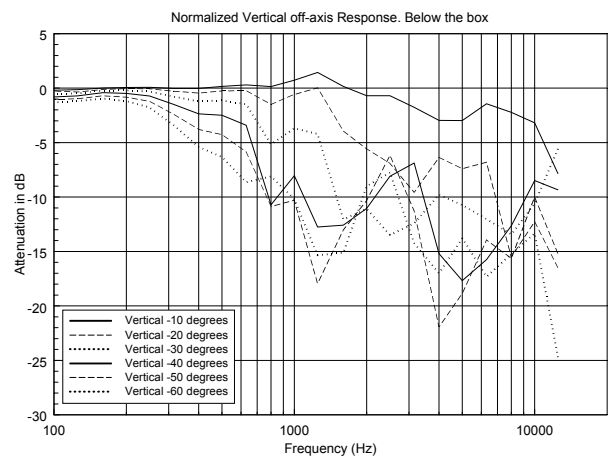
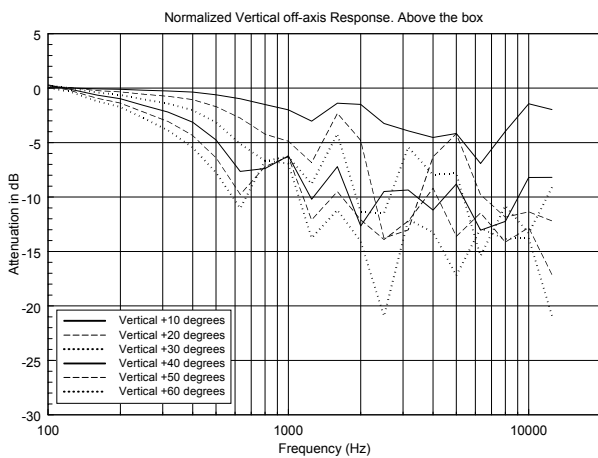
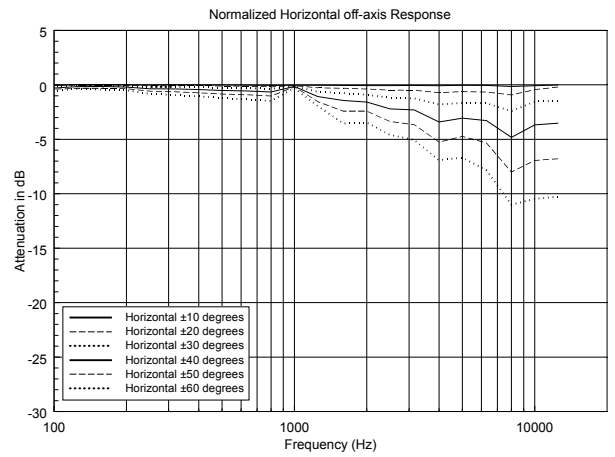
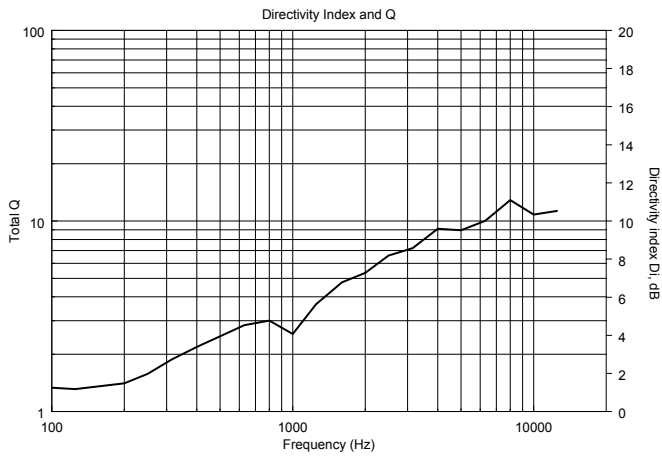
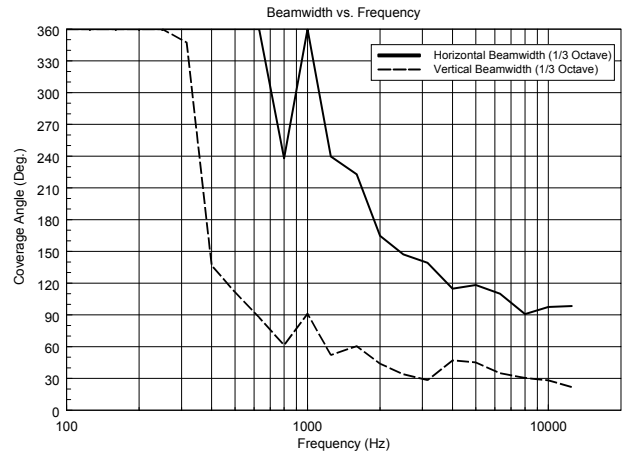
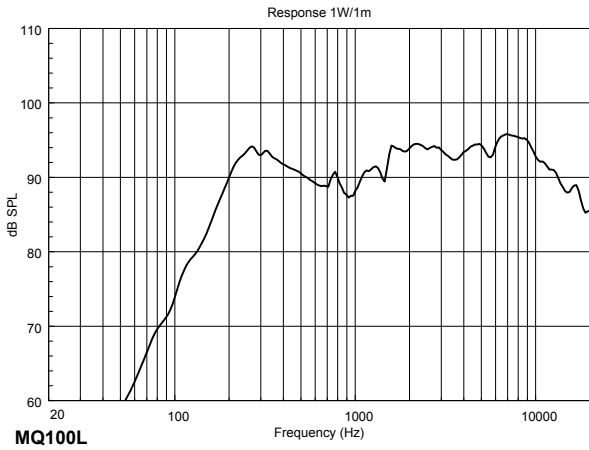

# MQ 100L

## HORIZONTAL 1/3 POLAR PLOT

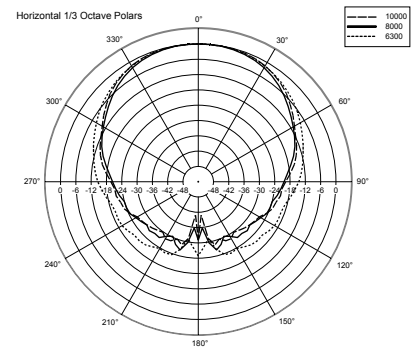
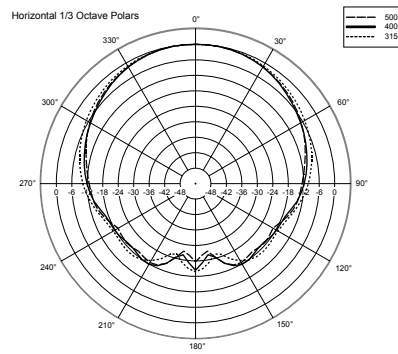
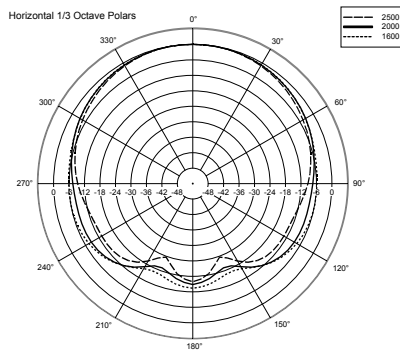
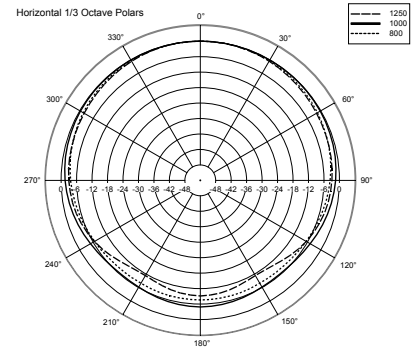
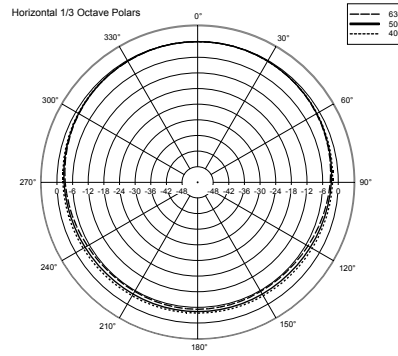
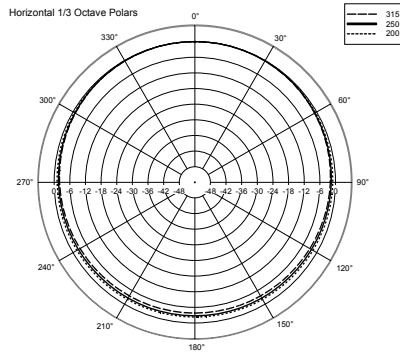

## VERTICAL 1/3 POLAR PLOT

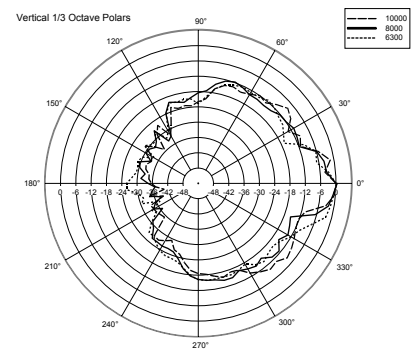
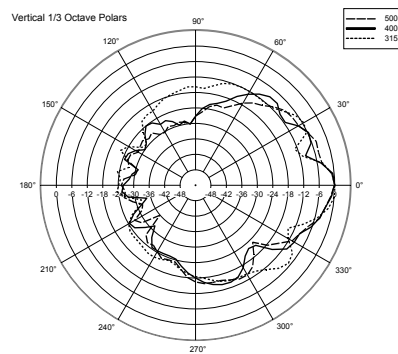
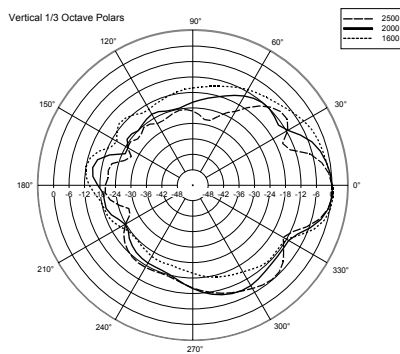
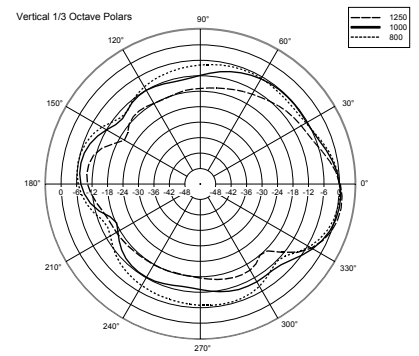
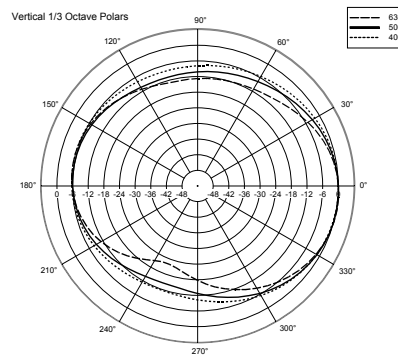
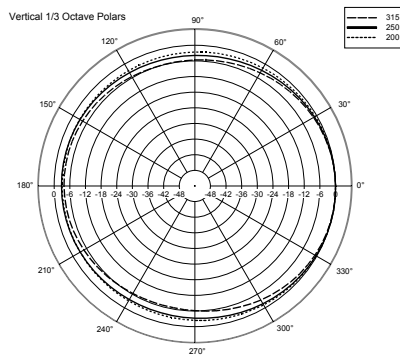

# MQ 100L

## PART NUMBERS

13000096 - MQ 80P-W White  
13000094 - MQ 80P-B Black  
13000095 - MQ 80P-S Silver

## DIMENSIONS (All data are in mm)

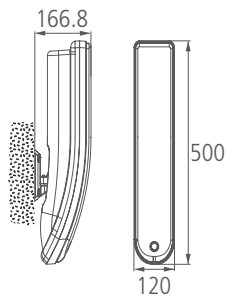

## INSTALLATION

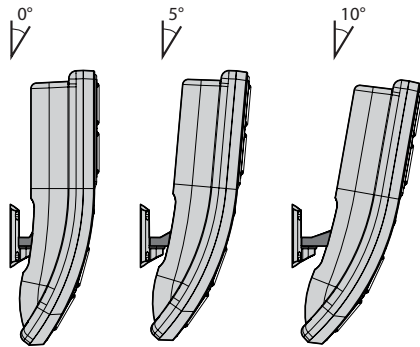

## SCHEMATICS

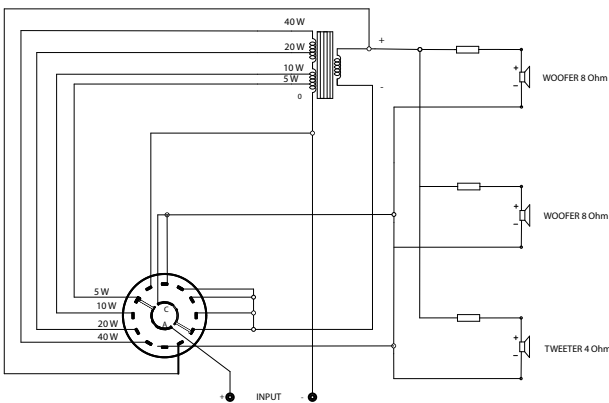

## INSTALLATION NOTES

Installation of the MQ 100L is quick thanks to accessories are included. These have been engineered to keep the column as close as possible to the wall and simplify the installation. Its tilt angle can be chosen among 0° – 5° – 10°. The 60° vertical dispersion is asymmetric: it is the difference between 20° upwards and 40° downwards. The vertical dispersion axis is in fact already angled 10° downwards, making it unnecessary to tilt the sound column excessively. The power can be easily selected by using the Rotary switch present on the front panel; the knob is accessible using fingers. Connections to the loudspeaker line are made by using Euroblock connector. The enclosure is constructed of high density UV resistant self-extinguishing polystyrene with robust steel grill.

RCF products are continually improved. All specifications are therefore subject to change without notice.

## POWER SELECTION

Set the rotary switch to selected the chosen power value referring to the 100 V line (among 5 W – 10 W – 20 W – 40 W) so the correspondence impedance (among 2000 Ω – 1000 Ω – 500 Ω – 250 Ω) or to the 16 Ω position (for low impedance connection).

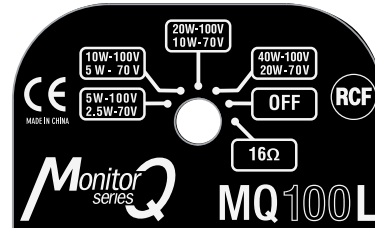

Note: if the rotary switch is set to the OFF position, the loudspeaker will be muted.

## CERTIFICATIONS AND APPROVALS

- CE comply with European Community Directive 73/23/EEC and 93/768/EEC
- Self-Extinguishing plastic according to UL 94V0
- Environmental protection IP 40 homologation
- Speaker data according to IEC 268-5
- Safety according to IEC EN 60065:2002

## ACCESSORIES (included)

- Safety steel wire
- Mounting bracket short, no tilt angle 0°
- Mounting bracket medium, tilt angle fixed to 5°
- Mounting bracket long, tilt angle fixed to 10°
- Connection Terminal
- Steel Grill



www.rcf.it