

# TTL31 WP

## PASSIVE LINE ARRAY MODULE



## DESCRIPTION

The TTL31 WP is a full range, ultracompact, wide dispersion, line array module that sets a new standard in the touring and theatre sound reinforcement, offering substantial power and efficiency for a variety of professional indoor or outdoor applications. TTL31 WP is a 2-way passive system featuring with 1 x 8" neo woofer 64 mm voice coil in horn loaded configuration, 3 x 1" neo compression driver 37 mm voice coil, titanium dome, in horn-array configuration. Each transducer has been specifically designed for the application. The woofer provides large excursion and very light weight and an incredibly high BL for best vocal presence, the unique compression driver design offer the minimum spacing between throats to avoid HF cancellation. Thanks to the extensive use of neodymium and new basket designs, the total weight of the 4 transducers is less than 6 Kg!

The internal passive filter provides crossover and equalization between the extended range woofer and the compression driver. The Crossover network offers Compression Driver Protection thanks to a unique design Active MOSFET Circuit.

TTL31 WP includes the LICC-Low Impedance Compensated Crossover that features markedly lower induction values in series with the woofer. The benefit is delay reduction, reduced phase shift and superior transient response. For a superior power handling high power, aluminium case, resistors are used in the crossover network. Dynamic high-frequency driver protection is accomplished with the RCF exclusive – Active Mosfet Compression Driver Protection System, chosen to complement the power curve of the driver. Connections to the amplifier are made through a watertight multi-pole connector IP67. The grille is in custom perforated aluminum with open-cell fibers and water repellent woven fabric backing.

The cabinet is constructed of multi-ply baltic birch plywood and finished in a very resistant, textured, polyurea black paint. The mechanical suspension and orientation system is in high quality steel, very precise and easy to use. The suspension system is directly connected to the aluminum sides of the cabinet. The suspension system is designed to have a safety factor 7 up to 16 speakers per side.

## MAIN APPLICATIONS

- Outdoor sound reinforcement
- Theatrical sound reinforcement
- Portable and installed audio-visual systems
- Front and under-balcony fill
- Houses of worship, ballrooms, concert halls and other fixed venue installations
- High quality reinforcement of music and speech

## MAIN FEATURES

- Very compact size (300 x 538 x 450 mm / 11.8" x 21.18" x 18.2")
- Maximum output per size available on market
- Wide, constant directivity, horizontal coverage angle
- 4 high power neodymium transducers
- Minimum weight
- Watertight multi-pole connector IP67
- LICC (Low Impedance Compensated Crossover Network)
- Baltic birch cabinet



# TTL31 WP

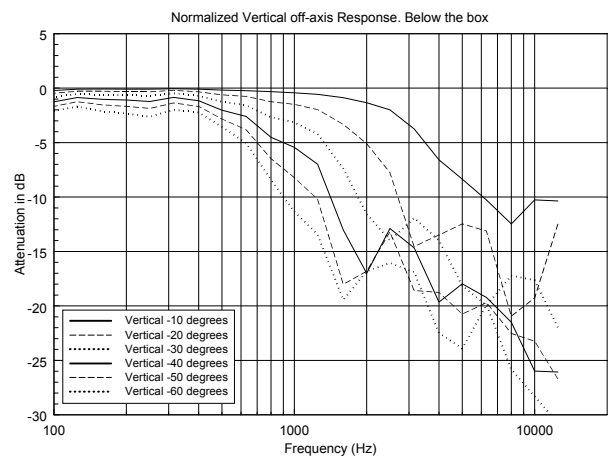
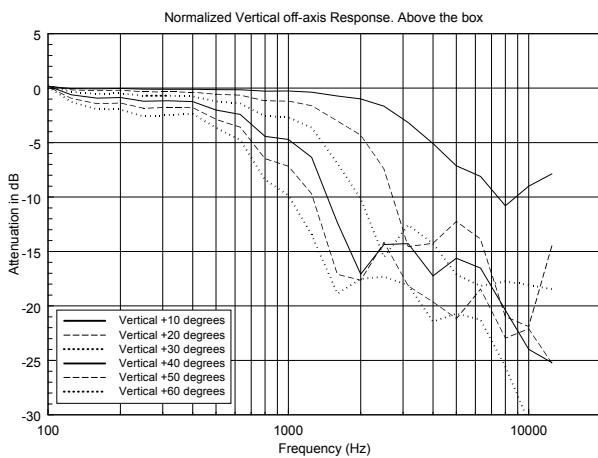
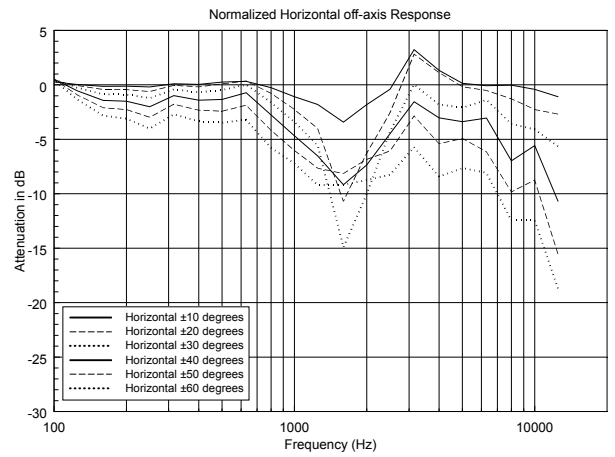
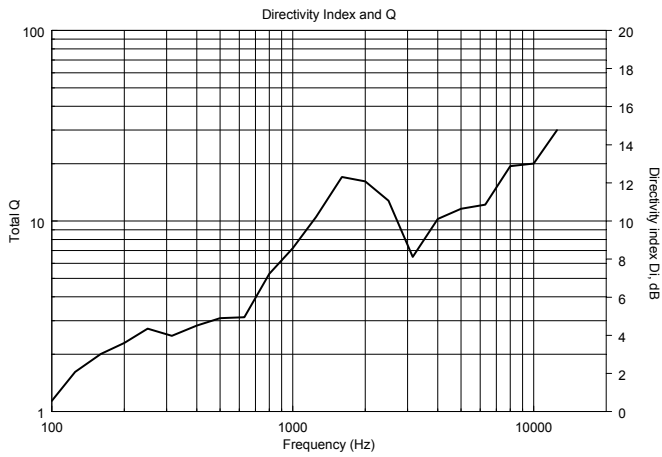
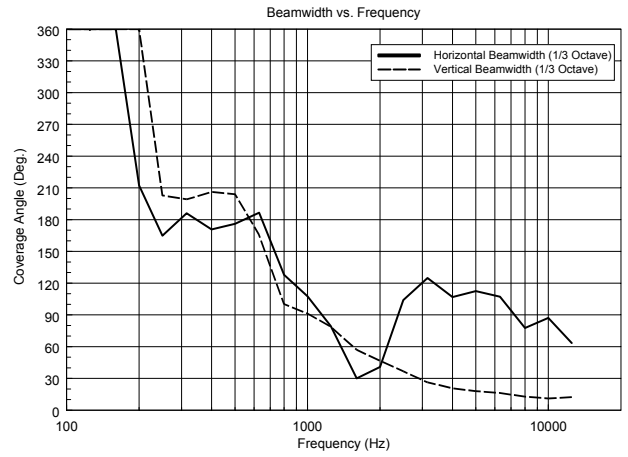
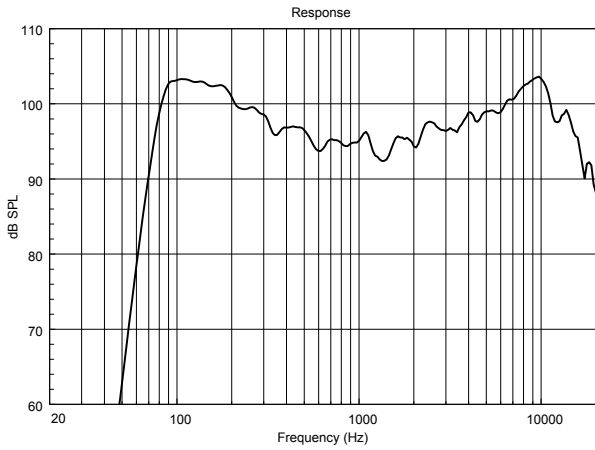

# TTL31 WP

## HORIZONTAL 1/3 POLAR PLOT

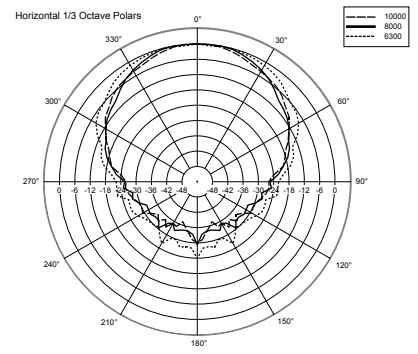
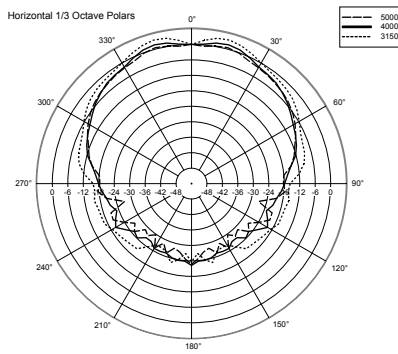
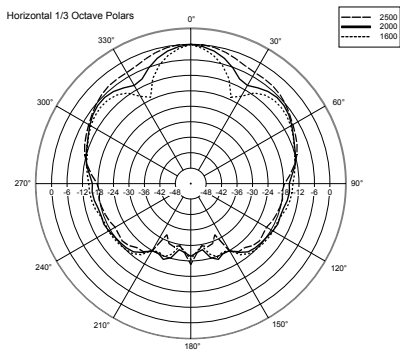
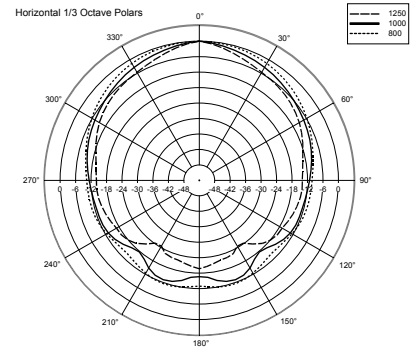
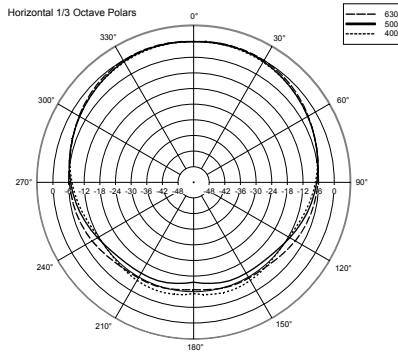
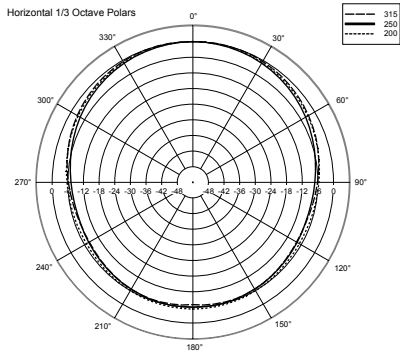

## VERTICAL 1/3 POLAR PLOT

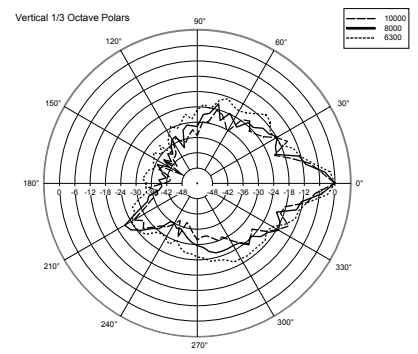
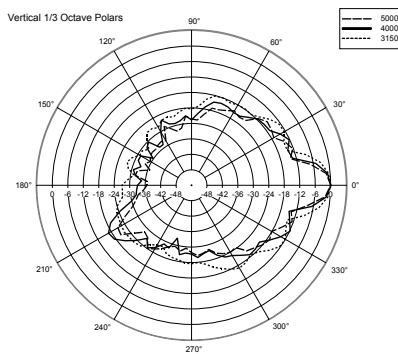
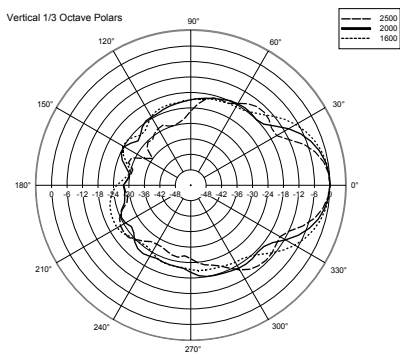
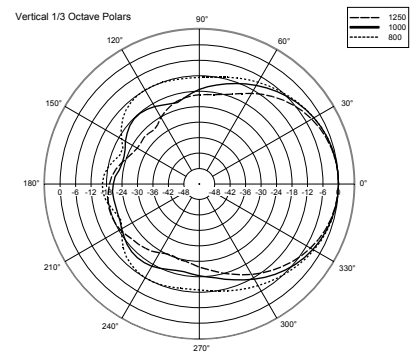
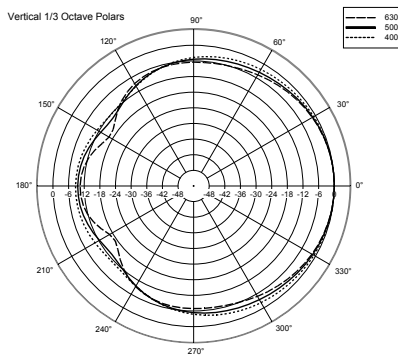
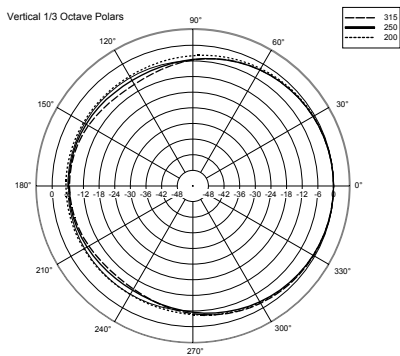

# TTL31 WP

## PART NUMBERS

13000250

## DIMENSIONS (All data are in mm)

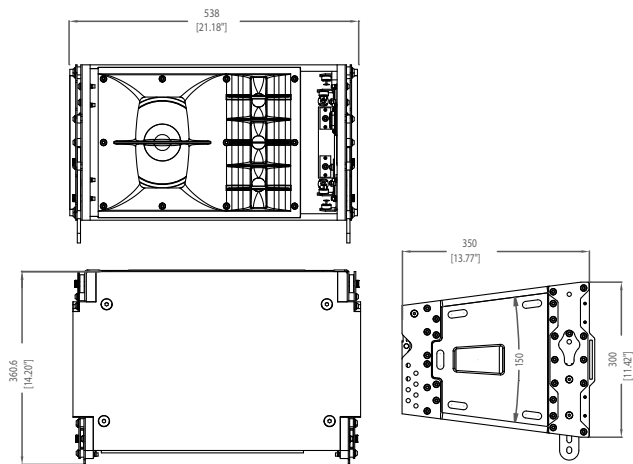

## ACOUSTICAL SPECIFICATIONS

Frequency response:	60 Hz ÷ 20 kHz
Max SPL:	128 dB
Sensitivity 1W/1m:	100 dB
Coverage angle:	H 100° x V 15°
Compression driver:	3x1.0" neo, 1.45" voice coil
Woofers:	8" neo, 2.5" voice coil
Power handling:	700W

## INPUT SECTION

Input signal (Impedance):	8 Ω
Input connector:	Amphenol eco/mat IP67
Output signal connector:	Amphenol eco/mat IP67

## PROCESSOR SECTION

Crossover frequencies:	1600 Hz
Protections:	Active Mosfet

## ACCESSORIES

FLY BAR TTL31	Barra di sospensione per il sistema array TTL31-A
STCK BAR TTL31	Accessorio da aggiungere al Fly bar TTL33, per il montaggio in stacking su subwoofer. Pin di aggancio rapido escluse.
AC PRO-FS	Steel speaker floor stand with folding base and telescopic rod, tube diameter 35mm. Load capacity up to 50kg, Weight 4.5 Kg, H MIN/MAX 137cm/210cm. Length once folded 102cm
AC 4PIN TTL31 NXL23	Kit di 4 pin di aggancio rapido per moduli array TTL31-A.
SHACKLE TTL33-TTL31	3,25 Tons for TTL33-A and TTL31-A array system.
LINK BAR TTL55-33-31	Barra per l'aggancio di un massimo di 8 moduli TTL33-A o TTL31-A ad un cluster di TTL55-A.

## PHYSICAL

Cabinet:	baltic birch
Dimensions (HxWxD):	300x 538x 450mm (11,8"x 21,18"x 18,2")
Weight:	19.2 kg (42.2 lbs)
Hardware:	side fly fittings
Handles:	2 on side
Pole Mount / Cap:	ready
Colour:	Black